

Push Button

SPB22-FR3-xxx-xxx

Description

Panel mounted Push buttons are used in a wide variety of applications and can be executed (without) LED lights and with a latching or momentary contact.



Features

Mechanical Properties	Description
Switch Operations	Momentary, Latching
Working temperature	-30 °C ~ + 85 °C
Operation Force	3N – 4,5 N
Button Surface	Flat
Configuration	1NO1NC, 2NO2NC
Illumination	Ring illumination
Terminal	Solder Terminals
Diameter	22 mm
Dimension	According to drawing
Protection Grade	IP67 / IK10
Mechanical lifecycles	500.000 times momentary 200.000 times latching
Material	Stainless steel , Aluminum oxide brass nickel-plated, Brass chrome-plated
Mounting	Panel Mounting

Push Button

SPB22-FR3-xxx-xxx

Electrical Properties	Description
Switch rating	5A/250VAC
LED	Included, common Anode/Cathode
LED Color	Green, Blue, Red, White, Yellow, RGB or a combination of colours
LED Voltage	3 V – 220 V
LED Current	3mA – 20mA
LED Life	40.000 hours

Dimensions

*unit: mm

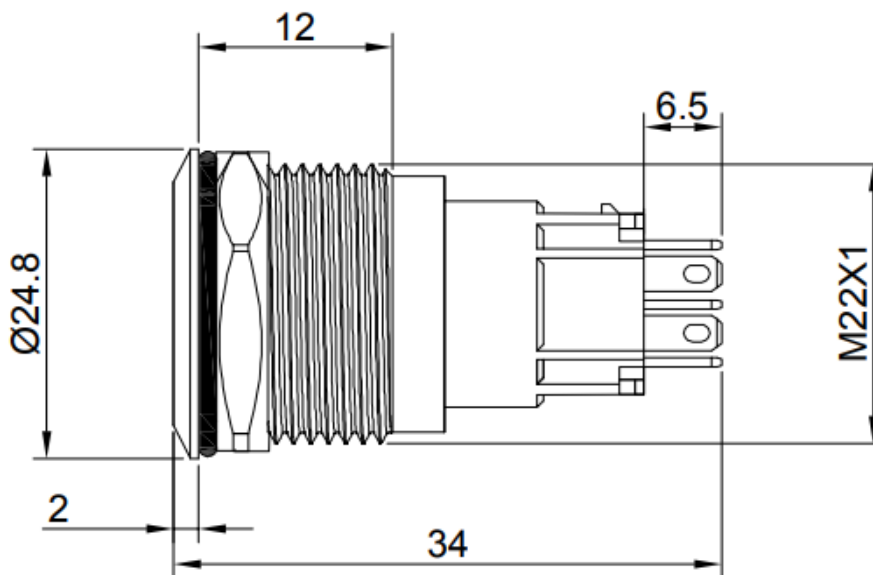

Push Button

SPB22-FR3-xxx-xxx

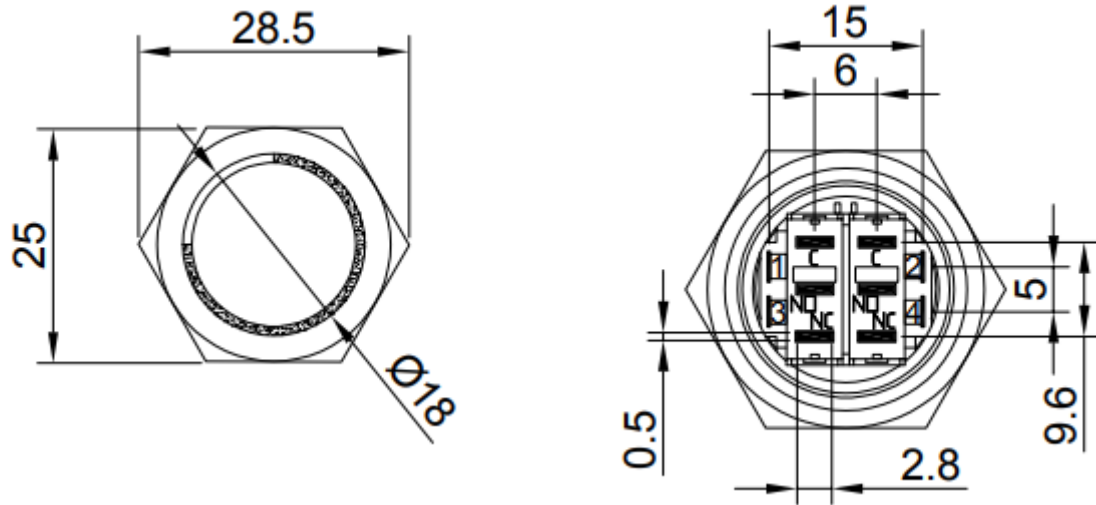

Ordering information

Ordering can be done via www.summit-electronics.com or via info@summit-electronics.com. Please contact us for more information. Customisation of the product is available on request.

Technical support

For all product questions please contact us via info@summit-electronics.com

Document revision

Rev	Date	changes
V01.00	23-12-2024	First issue of document